

EXHIBIT A

Koll Center

Sierra Point

Building-Mounted

Signage

Standards

City of Brisbane

Brisbane, CA



1/28/10

10/14/98
12/14/00

8/10/00
2/13/01

11/30/00
1/9/03

Table of Contents

- I. Purpose
- II. Review Procedure & Submittal Requirements
- III. Elements
- IV. Quantity
- V. Placement
- VI. Scale
- VII. Color
- VIII. Materials
- IX. Owners installation Criteria

Applicant

Tenant who desires a building-mounted sign.

Owner

Owner of building on which applicant wishes to have sign installed.

Developer

Koll Center
Sierra Point
Mr. Doug Thomas
1000 Marina Blvd.
Brisbane, CA
415-952-5335

City

The City of Brisbane
Building and Planning
Department
440 Visitacion Ave.
Brisbane, CA
415-467-4180

Design Consultant

Colophon Inc.
Planners & Designers
900 North Point Street
San Francisco
California 94109
414-775-8899

**Building Mounted
Signage Standards**

I. Purpose:

The purpose of the signage standards is to provide standards to safeguard life, health, property and the public welfare, and to provide the means for adequate identification of buildings and businesses by regulating and controlling the design, location and maintenance of all signs on office and hotel buildings within Koll Center Sierra Point that are located in Brisbane. Therefore, these standards do not apply to the Brisbane portion of the site that pertains to the retail area nor do they pertain to the South San Francisco portion of the site. The "Revised General Sign Standards" dated June 23, 1984 and amended November 17, 1986 pertain to all signage standards at Koll Center Sierra Point, excluding building-mounted signage.

The intent of this program is to establish specific standards for all exterior building-mounted signage that will ensure continuity, consistency, and harmony with the master-planned architectural quality of Koll Center Sierra Point.

**II. Review Procedure
Submittal Requirements:**

Permits are required

All signs which fall under the control of these standards require permits issued by the City of Brisbane. The following review process is specifically pertinent to owner review and approval..

Submittal Requirements

A sign review permit, issued by the City of Brisbane, is required for all building mounted signage. The permit application must first be approved by the building Owner, then by the Developer of Koll Center Sierra Point. The application is then submitted to the City Planning Department for an approval if it is determined to be consistent with these signage standards. Signage that is determined to be inconsistent can only be allowed through approval of a variance by the City of Brisbane Planning Commission.

The necessary submittal steps for review and approval are as follows:

1. For Preliminary Approval by Developer

- Exact photostat of symbol and/or logotype
- Sample of color and material
- Drawings showing proposed placement and scale
- Completion of request form
- Notations of proposed materials, finishes, and color

2. For Sign Review Approval by City Planning Department

- Completed sign review application with Owner's signature and fee.
- One reproducible and legible site plan (maximum size: 11" x 17") to an appropriate scale showing the location of all proposed and any existing signs on the subject building.

- One set of reproducible and legible elevation (Maximum size: 11" x 17") showing the location and appearance of the sign(s) on the building (including side views where necessary) to an appropriate scale as an exact representation of the proposal.
- Description of materials and methods of finishing and installation (thicknesses, treatment of edges, details of framing, type of lighting, if any, etc.). This information can be placed on the elevations as appropriate.
- One set of color samples (minimum size: 1" x 1"), showing exact shades and keyed to sign elevations.
- One set of color photographs showing the proposed location of the sign(s).

3. For Variance Consideration

Sign proposals which do not meet these standards must be reviewed by the City's Planning Commission. Contact the City's Planning Department for submission requirements. There are specific legal requirements for the approval of any variance and there is no guarantee of approval once a variance application is submitted.

4. For Final Approval by Developer

- Final drawings for placement and scale
- Electrical and Structural specifications
- Final materials, finishes and colors
- Schedule for installation
- Proof of insurance by contractors
- Installation and Weatherproofing details

SONY

Diagram 1:

Acceptable Logotype Only

A B C D E F G H I J K L M N O

P Q R S T U V W X Y Z

a b c d e f g h i j k l m n o

p q r s t u v w x y z

Diagram 2:

Standard Building Font is Franklin Gothic Bold



Diagram 3:

Acceptable Symbol Only

5. Building permit application submittal requirements

- Three sets of plans as described in section 1.2.1 of Owner's Installation Criteria.
- State worker's compensation certificate made out to the City of Brisbane.
- State contractor's license number
- City of Brisbane contractor's business license

III. Elements

3.1. Logotypes (*Diagram 1*)

3.1.1. Primary company logotype/symbol, acceptable

The Applicant shall use its primary corporate identity (i.e.: corporate logotype or symbol as applied to business papers or products, etc.) to form the basis for its building signage. Special case identification, product names and other variations of the corporate signature shall be excluded.

3.1.2. In lieu of Applicant supplied standard, Building typography standard takes precedence

(Diagram 2)

If the Applicant lacks a characteristic logotype/ symbol and requests that its corporate name be applied in building signage, the corporate name shall conform to typographic standards outlined in these guidelines.



Diagram 4:

Acceptable Symbol + Logotype



Diagram 5:

Acceptable Symbol + Logotype
with unacceptable secondary line of text.

3.2. Symbols (*Diagram 3*)

3.2.1. Primary company symbol acceptable

Symbols may be used alone without a supporting logotype. The use of a wordmark (IBM) rather than a complete spelling of a corporate name (International Business Machines) is preferred for use as signage.

3.3. Logotypes and Symbols together (*Diagram 4*)

3.3.1. Combined logotypes and symbols will be allowed. Preference will be for Logotype application alone

Combined symbols and logotypes shall be allowed only if the elements can be contained as a single sign element mounted to the building. Multiple and separate sign structures are disallowed.

3.4. Exclusions

3.4.1. Not allowed are secondary lines of information, advertising by-lines, or Subsidiary identification (*Diagram 5*)

Secondary lines of text in or around the company identity, including subsidiary organization identification, advertising slogans, bylines or statements of any kind shall not be permitted, except as approved by the Planning Commission specifically in order to describe hotels and restaurants.

IV. Quantity

4.1. Maximum of 2 different tenants' signs

A maximum of 2 different tenants' signs may occupy a given side of any building within Koll Center Sierra Point.

4.2. Maximum of 4 signs per building

A maximum of four tenant identification signs may be placed on any building within Sierra Point, excluding signs permitted for the sides of hotels not visible from Highway 101 per Section 4.4.

4.3. No more than 2 signs applied to any side

On any specific building side no more than two tenant identification signs shall be placed.

4.4. Clearly visible signage from highway

Signage on any one side of a given building shall be clearly visible from northbound or southbound traffic on Highway 101, *except that hotels may be permitted signage on sides of the building not visible from Highway 101 as determined by the Planning Commission per Section 5.1.*

V. Placement

5.1. Location to be determined by the Developer and the City

For any new building subject to these guidelines, the sides of the building on which signage is permitted per the preceding section shall be determined by the Planning Commission at the time of Design Review.

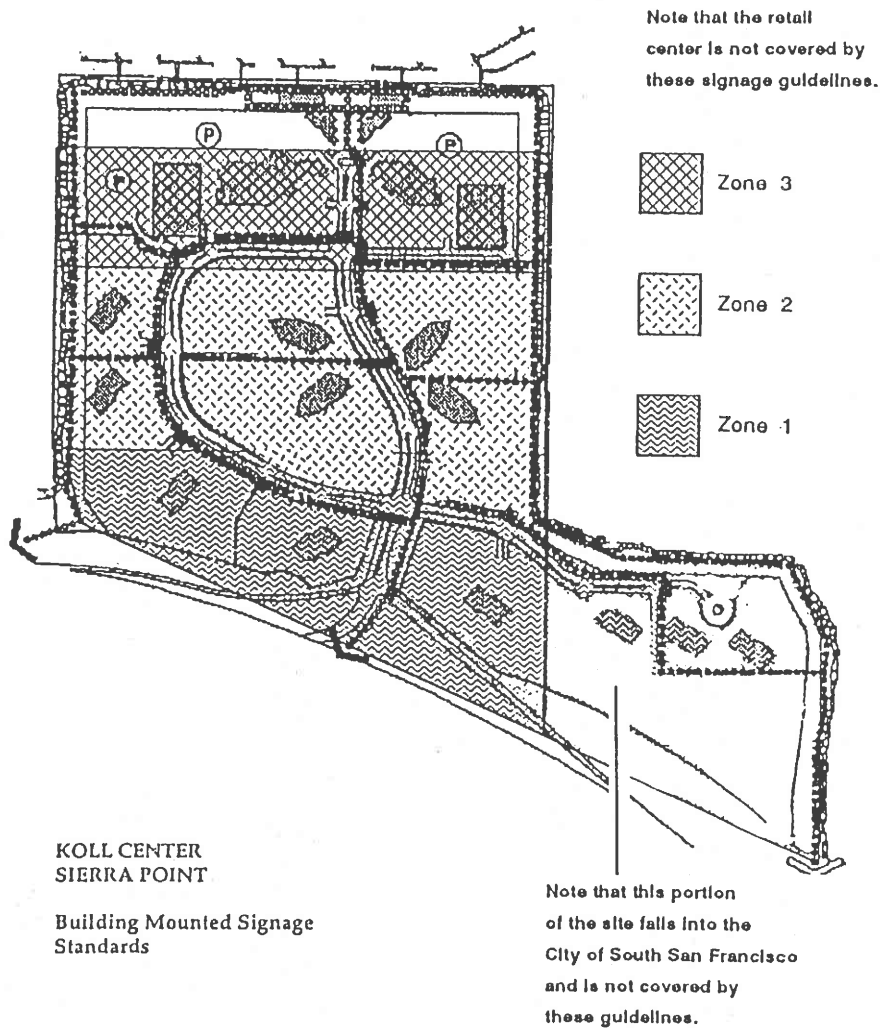

Diagram 6:
Building "zones"

The Developer shall determine the appropriate height and location for all tenant identification signs placed on the building prior to submission to the City's Planning Department for final approval. Due to the variable nature of each building's architectural design and the freeway site-line (view) corridor, the location of signage of each building shall be assessed on a project-by-project basis by the Developer and Planning Department of the City of Brisbane.

VI. Scale

6.1. Scale shall be determined by the relative "zone" that the building occupies (**Diagram 6**)

6.1.1. Sign scale from freeway view corridors

Signs shall conform to a maximum x height in three zones so that the apparent scale of signage is approximately the same from freeway view corridors.

6.1.2. Site shall be defined in 3 zones from freeway plane

The site shall be organized into lateral zones which parallel the 101 freeway is outlined in 6.1.3, below. Signage scale shall be controlled by the location of buildings within these zones.

6.1.3. Size Regulations

The maximum size (vertical and horizontal) for each zone is outlined below. However, the intent is to have a sign that is in scale with the size of the building, so these maximum sizes may not always be permitted. The size shall be approved by the Developer prior to submittal to the City of Brisbane for approval by its Planning Department.

Note that the maximum area permitted for the sides of hotels not visible from Highway 101 per Section 4.4 shall be not more than one-half (1/2) that permitted above.

The Planning Commission may approve exceptions to the maximum dimensions and area permitted above for hotel signage, if the Planning Commission determines that:

- The larger size is necessary to provide adequate legibility of the signage; and
- The signage is designed so as to substantially fit within the building's architectural elements or details.

Also note that, in permitting a secondary line of identification for hotels and restaurants, the Planning Commission may approve exceptions to the maximum vertical dimension permitted, subject to the following:

- The sign fits within the building's architectural elements or details.
- The sign complies with the maximum horizontal dimension and area permitted above.

Zone Location	Max Vertical	Max Horizontal	Area
Zone One	5'.0"	35'.3"	176.25'
Zone Two	6'.0"	41'.6"	249.00'
Zone Three	7'.0"	48'.0"	336.00'

6.1.4. Views clear from all floors

All signs shall fit within the architectural features so that the letters do not extend above or below the spandrel glass so as to block views from any floor.

6.1.5. Method for measuring scale correctly.

The vertical, horizontal and area standards set by section 6.1 shall be measured as follows: The vertical dimension shall be measured at the maximum height of any letter, excluding descenders or symbol (see **Diagram 7**). The horizontal dimension shall be measured at the maximum horizontal length

encompassing all pictorial and typographic elements (see **Diagram 7**). The area shall be measured as the product of the vertical and horizontal dimensions as measured above.

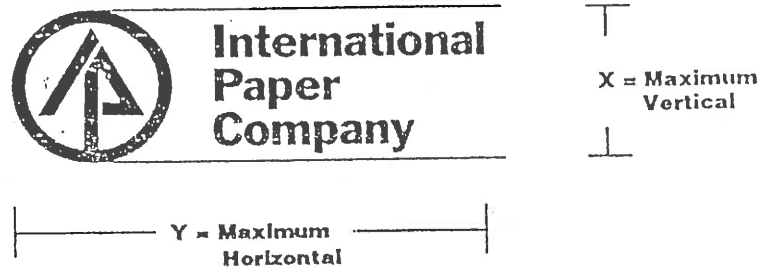
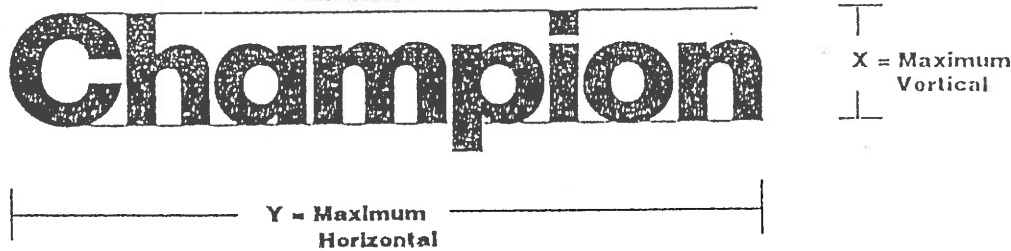

VII. Color

7.1. Review Authority

7.1.1. Consistent with established guidelines

Color shall be regulated by these standards, but shall be subject to the Owners' approval prior to submission to the Developer and City for review and approval of the color to insure conformance with those guidelines and other existing approval requirements.

Diagram 7:

Method for Measuring Sign Dimensions

Berthold

Berthold

Diagram 8:

3-D Characters Mounted to Building Surface

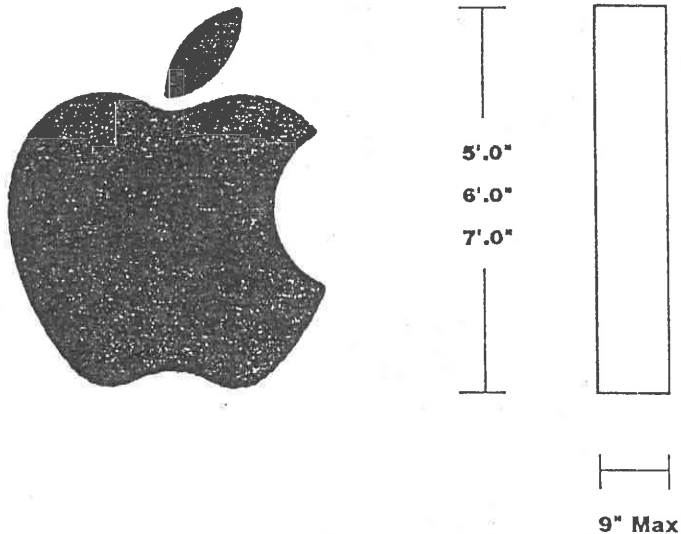

Diagram 9:

Maximum Symbol/Logotype Thickness

7.2. Color shall be allowed under the following conditions

7.2.1. Tenant color standards

Color of sign elements shall be confined to a palette of red, blue, green, white and black. The City's Planning Department may refer sign permits to the City's Planning Commission for approval if the requested sign color is one other than those listed above. A final determination on the use of color shall be made by the Developer and the City of Brisbane consistent with the architectural design finishes of each building and the tenant's corporate identity program.

7.2.2. As appropriate to building surface coloration

In the event that the tenant identity program does not embrace specific color requirements, a color standard appropriate to the surface coloration of the building shall be developed and applied to the tenant sign in question. Such color standards shall be approved by the Developer and City of Brisbane.

VIII. Materials

8.1. Sign Type

8.1.1. Internally illuminated "can" characters. Plexiglass character faces Electrically illuminated for night visibility. Sheet metal with neutral anodized finishes

Signs shall be fabricated of anodized sheet aluminum in two finish specifications: clear or grey

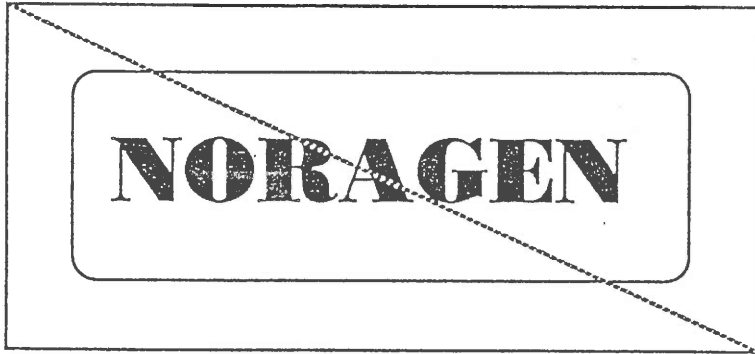

Diagram 10:

Fields Not Allowed

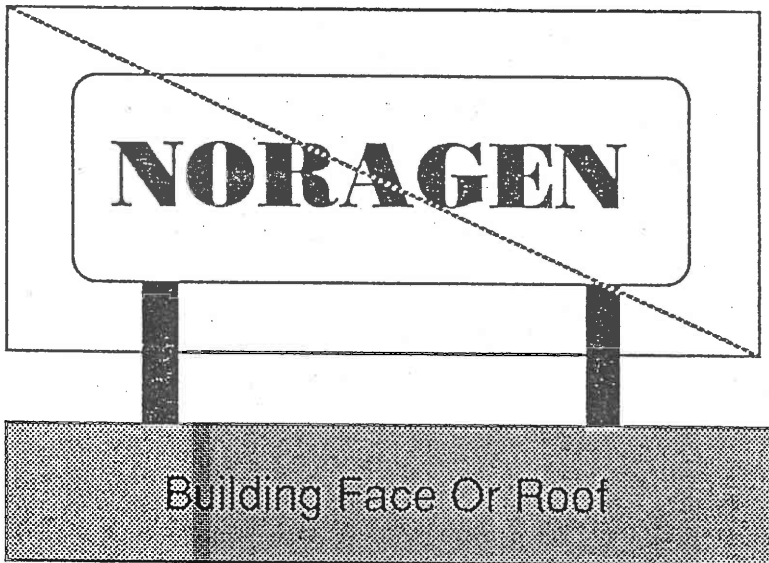

Diagram 11:

Ancillary Structures Not Allowed

anodizing for light colored building surfaces and dark bronze anodizing for dark colored building surfaces. Characters and/or elements shall be three dimensional and shall conform to a maximum depth of 9 inches from face of sign to building surface. Signs may be internally illuminated and shall have acrylic faces which are reflective during the day and translucent at night. However, no flashing signs are permitted. Please see **(Diagram 8 & 9)** for further details.

8.1.2. Unacceptable sign types (Diagram 10)

Illuminated fields upon which characters rest. Under no condition will fields or areas be allowed as "buffers" upon which signage may be applied. Only the outline characters of the tenant identity are allowed.

Neon or exposed fluorescent elements

No exposed lighting fixtures, tubes, ballasts, wiring or other equipment shall be allowed.

Chrome or metallic characters

No metallic, polished or highly reflective characters shall be allowed.

Ancillary structures or features to support sign

(Diagram 11)

Frames, posts or any kind of structures which serve to elevate or project the sign from the building surface shall not be allowed.

Owners Installation

Criteria

1.1 Introduction

The owner installation criteria which follow have been provided as guidelines for signage installation. However, signs should be examined on an individual basis to determine how these guidelines apply to specific sign requirements, given the unique nature of each building structure.

1.2. Fabrication

1.2.1 Accepted standards and practices

Contractors, fabricators and installers shall submit 3 copies of shop drawings, finish specifications, structural and electrical details and installation plans to the building owner for approval before any work can proceed. Furthermore, the Tenant and/or the tenants' contractors shall maintain a minimum of \$1,000,000.00 in liability and \$500,000.00 incidental property damage insurance while installation of signage is underway on the building premises.

Proof of insurance and indemnification of the respective building owner against any claims, liens or legal actions resulting from the fabrication and installation shall be filed with the building owner before any installation work begins. Sign review and building permits must be approved by the City of Brisbane and filed with the Owner before any work can begin.

1.2.2 Electrical code requirements

Electrified signs shall meet all UBC, ULL and local building ordinances. All electrical components must be capable of sustained weathering and temperature extremes. Electrical component servicing must be accessible from a crane or lowered stage without penetrating curtain wall or fascia of building.

1.2.3 Other requirements and restrictions

Wind load factors

All building signage shall be capable of sustaining 85 mph winds without risk of damage or demounting of sign. Any damage or personal injuries caused as a result of damaged or lost signage shall be the responsibility of the contractor.

Weight limitations

Tenant's contractor shall submit for Owner's approval the weight and structural load calculations indicating the mounting method and loading factors before any signage is mounted to the building. The sign shall be designed to be as light as possible.

Engineering Specifications

The Tenant shall secure the services of a qualified structural engineer to verify that the proposed sign shall meet the conditions contained within this Installation Criteria and shall be structurally sound. Verification of wind load, weight and installation factors shall be made available to the building owner at the time the Tenant submits a permit application.

1.3 Installation

1.3.1 Installation methods acceptable

The Tenant and its contractors shall provide drawings to the Owner which indicate the method of installation prior to submission for permits. The Owner reserves the right to reject installation methods when those methods have a derogatory effect upon either the structural soundness or the appearance of the building.

1.4. Maintenance

1.4.1 Access for maintenance requirement

Periodic maintenance of signage shall be accommodated from the exterior of the building. Except for electrical feeds, all maintenance and repair shall be conducted from either a crane or a stage. All signs shall be maintained in a neat and orderly fashion. Periodic inspections shall be made by the Developer. Prompt correction of any deficiencies shall be made by the responsible party for the maintenance of the sign(s).

1.4.2 Acceptable response time for damage repair

Damaged signs shall be repaired within 30 working days from the date of the damage, or be removed entirely from the building facade within 60 days. Should removal become necessary, the Tenant shall repair the building surface where signage has affected either structural conditions or visual appearance.

1.4.3 Responsibility for damage

Damage to Tenant signage is entirely and solely the responsibility of the Tenant.

REVISED
GENERAL SIGN STANDARDS
KOLL CENTER SIERRA POINT

BRISBANE, CALIFORNIA

~~SOUTH SAN FRANCISCO, CALIFORNIA~~

June 23, 1984

Amended (Group II)

November 17, 1986

Amended (Group I)

_____, 1988

KOLL CENTER SIERRA POINT SIGN PROGRAM STANDARDS

EXCLUDING BUILDING-MOUNTED SIGNAGE

PURPOSE AND INTENT

The purpose of the Sign Program Standards is to provide minimum standards to safeguard life, health, property and the public welfare, and to provide the means for adequate identification of buildings and businesses by regulating and controlling the design, location and maintenance of all signs within Koll Center Sierra Point.

The intent of this program is to establish specific standards for all exterior signing that will ensure continuity, consistency, and harmony with the master-planned architectural quality of Koll Center Sierra Point.

MAINTENANCE

All signs shall be maintained in a neat and orderly fashion. Periodic inspections shall be made by Koll Center Sierra Point. Prompt correction of any deficiencies shall be made by the entity responsible for the maintenance of said sign(s).

APPROVALS

The following Sign Program Standards have been approved by the City of Brisbane. Individual signage must have the approval of both the Koll Center Sierra Point Design Review Committee, consisting of members appointed by The Koll Company or its successors in interest, and the City of Brisbane. Tenants eligible for exterior signing shall be determined by Koll Center Sierra Point. Prior to obtaining approval from the City of Brisbane, sign applicants shall first obtain the approval of Koll Center Sierra Point by submitting the following:

1. For Preliminary Approval submit the following in triplicate to Koll Center Sierra Point:
 - a. Complete building elevation showing the proposed sign location and size with dimensions.
 - b. Notations as to the proposed materials, finishes and colors.

2. For Final Approval submit shop drawings containing the following in triplicate to Koll Center Sierra Point:
 - a. Complete building elevation showing the proposed sign location and size by dimension.
 - b. Details, materials, finishes and colors.
 - c. Proposed method of attachment to building and water-proofing at building penetrations.
 - d. Electrical power requirements.
3. For City Approval submit shop drawings as approved by Koll Center Sierra Point first to the City of Brisbane Planning Department, then to the Building Department.

UNCERTAINTY OF SIZE STANDARDS

If a situation arises that is not covered by these sign standards or there is ambiguity of these standards, the sign applicant shall be referred to both the Koll Center Sierra Point Design Review Committee and the City of Brisbane Planning Department for determination and clarification. The Design Committee and Planning Department shall then authorize signing which best fulfills the intent of the Sign Program Standards.

COMPLIANCE REQUIRED

No person shall erect, re-erect, construct, enlarge, alter, move, improve, remove, convert or equip any sign or sign structure, or cause or permit the same to be done contrary to or in violation of any of the provisions of the Sign Program Standards. Conformance will be strictly enforced by Koll Center Sierra Point and the City of Brisbane Planning Department. All such unapproved sign(s) must be brought into conformance at the expense of the persons responsible for the installation of said sign(s).

SUPPLEMENTAL EXHIBITS

The attached exhibits are intended as a graphic aid in interpreting the intent of the Sign Program Standards.

In conjunction with the working drawings for each building, a graphic exhibit will be prepared indicating the permitted number, size and location of Group I Signs. Said exhibit shall be on file at the City of Brisbane Planning Department to facilitate the plan check process.

GENERAL SIGN STANDARDS

1. Signs are grouped into three groups. The size, location and design of each sign shall not exceed the specific maximum limitations for each group. For building wall signs, the criteria for this determination shall be proportional compatibility and harmony with the overall building and with the elevation upon which the sign is to be placed.
2. The area of a sign or logo with individual letters shall be measured by a rectangle around the outside of the lettering and/or the pictorial symbol.
3. The introduction of color on pictorial or abstract logo symbols shall be permitted only when it is essential to the readability of the symbol and shall be limited to one additional color.

GROUP I - EXTERIOR ENTRY DOOR SIGNS

~~GROUP I - BUILDING WALL SIGNS~~

GROUP I - SIGN STANDARDS

1. Signs and logos attached to the exterior of any building may be internally illuminated, but no signs or any contrivance shall be devised or constructed so as to rotate, gyrate, blink or move in any animated fashion.
2. All signs and logos attached to the building shall be of individual letters and surface mounted. No "can" signs or signs painted directly on the building shall be permitted.
3. The area of a sign or logo with individual letters shall be measured by a rectangle around the outside of the lettering and/or the pictorial symbol.

4. The letter style for all signs attached to the building exterior shall be Helvetica Medium, all upper case, unless a specific company, firm or corporation letter style is approved.

5. Colors shall be determined by the architectural design of the building the sign is attached to:

- a. Glass Curtain Wall Facade: The face of all wall sign letters and pictorial symbols shall be white with the sides (returns) of the letters finished to match the individual building exterior aluminum trim color.
- b. Precast Concrete Facade: The face of all wall sign letters and pictorial symbols shall be bronze No. 2370 "Plexiglas" backed up with white No. W-7328 "Plexiglas". The daytime effect will be of black letters. When internally illuminated at night, the letters will appear as white. The sides (returns) of the letters shall be finished in black or to match the concrete face color.

Subject to approval, the introduction of color on pictorial or abstract logo symbols shall be permitted only when it is essential to the readability of the symbol and shall be limited to one additional color, preferably black or bronze.

GROUP I - SIGN DESCRIPTIONS

~~1. Sign Type Ia: Primary Building Identification Signs~~

~~This sign type shall be limited to the identification of the major tenant and shall be limited to two (2) elevations and located on the top floor fascia or spandrel area. These signs can be internally illuminated or non illuminated. See General Sign Standards, paragraph "C", for color restrictions.~~

~~The size and location of each sign shall be designed to be complimentary and proportional to each individual building and in no case shall said sign exceed 200 square feet in area and a height established by the following table:~~

Sign Level (Stories)	Maximum Letter Height
1	2' - 6"
2	2' - 8"
3	2' - 10"
4	3' - 0"
5	3' - 4"
6	3' - 9"
7+	4' - 3"

~~2. Sign Type Ib: Secondary Wall Signs~~

~~This sign shall be limited to the identification of secondary tenants with a maximum of one sign per tenant. Subject to approval, a secondary tenant may be permitted one (1) additional sign. In no event, shall there be more than four (4) permitted secondary wall signs per building, and not more than one (1) sign per building elevation.~~

~~Said signs shall be individual letters internally illuminated or non-illuminated. The letter style for these signs shall be Helvetica Medium, all upper case. See Sign Program Standards, paragraph "C", for restrictions on sign colors.~~

~~The size and location of each sign shall be designed to be complimentary and proportional to each individual building, and in no case shall said sign exceed eighteen (18) inches in height, nor sixty (60) square feet in area, nor exceed fifty (50) percent of the horizontal dimension of the elevation to receive said sign. Elevation is defined as a contiguous vertical plane.~~

~~Subject to approval, a secondary tenant may be permitted signage above the first floor and/or of a larger size so long as said signage is considered to be complimentary to the specific building design. In no event shall said signage exceed the limitations established for primary building identification signs (Sign Type Ia).~~

~~3. Sign Type Ic: Exterior Entry Door Signs~~

These signs shall be limited to identification of exterior tenant entry doors and shall be classified into one of two groups:

a. Type 1: Parking Area Signs

These signs shall be located on building elevations which face parking areas.

Said signs shall be individual letters internally illuminated or non-illuminated. The material and finish shall be established for each building. The letter type for these signs shall be Helvetica Medium, upper and lower case. The size and location of each sign shall be designed to be pedestrian oriented and to be complimentary and proportional to each individual building and entry area, and in no case shall said sign exceed eight (8) inches in height nor eight (8) square feet in area.

b. Type 2: Plaza Area Signs

These signs shall be located on building elevations which face hardscaped plaza areas created by a cluster(s) of buildings.

Said signs shall be individual three (3) dimensional cast metal letters affixed to the sidelight. The letter type for these signs shall be Helvetica Medium, upper and lower case. The size and location of each sign shall be designed to be pedestrian oriented, and to be complimentary and proportional to each individual entrance. In no case shall the sign exceed two and one half (2 1/2) inches in height.

~~GROUP 1
BUILDING WALL SIGNS~~

~~1a - Top of the Building Identification Signs~~

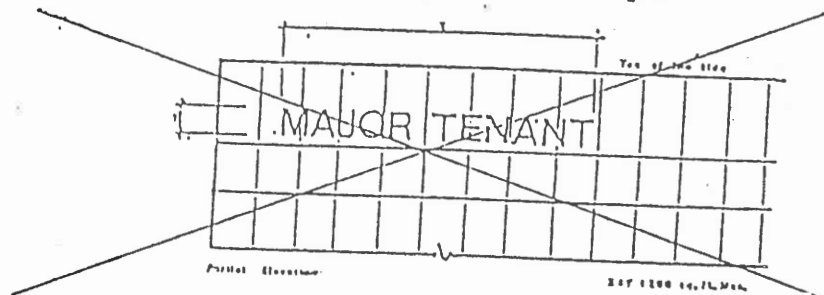

~~1b - Secondary Wall Signs~~

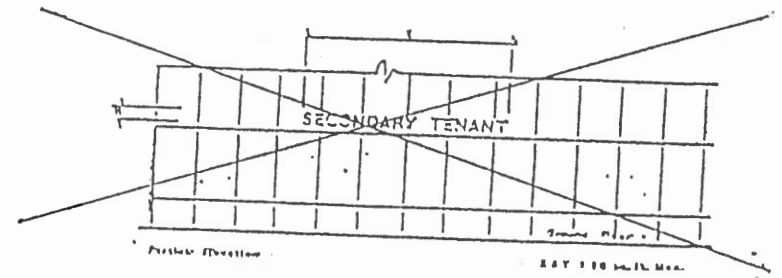

~~1c - Exterior Entry Door Signs~~

Type 1

Type 2

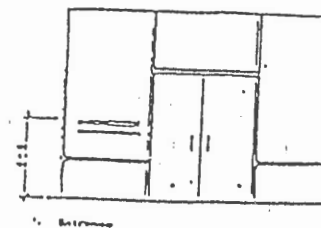
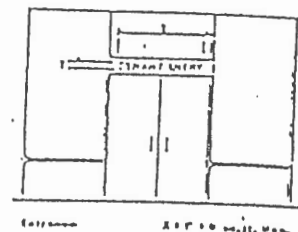

GROUP II - PERMANENT GROUND SIGNS

GROUP II - SIGN STANDARDS

1. All anticipated permanent ground sign types have been addressed in this document.

No additional permanent ground signs shall be introduced without the approval of the Koll Center Sierra Point Design Review Committee and City of Brisbane Planning Commission.

2. All sign types, sizes, colors and materials shall conform as indicated herein except that the City of Brisbane shall have the right to select alternative designs for their Marina buildings. Tenant logos may be incorporated in sign type "D" with the approval of the Koll Center Sierra Point Design Review Committee and the City of Brisbane Planning Director.
3. Palatino type face shall be used in bold and regular on all permanent ground signs as shown in Exhibit J, page 22. The bold type face is for project identity and on directional signs, sign type "E" through "I". Palatino regular type face is used on remaining messages. No type face deviation shall be allowed without the approval of the Koll Center Sierra Point Design Review Committee and the City of Brisbane Planning Director.
4. All traffic signs shall conform to the State Design Manual and State Traffic Manual. The location and design of the traffic signs shall be reviewed and approved by the City of Brisbane Director of Public Works.
5. Parking Directional Signs (sign type "E") are to be reviewed and approved for number and location by the City of Brisbane Planning Director and Public Works Director.
6. Building Identification Signs (sign type "D") are to be limited to one per building *plus one for any secondary street frontage*, and location shall be approved by the City of Brisbane Planning Director prior to the issuance of a building permit.

GROUP II - SIGN DESCRIPTION

1. Sign Type A - Directory Kiosk

The Directory Kiosk shall be located at the entry to the park, parallel to Sierra Point Parkway and adjacent to the sidewalk.

Description: Addresses and buildings are identified by colored squares that refer to the site plan. Two GFRC panels with reveals are mounted to metal substructure which is supported by a concrete foundation. Top band to be polished copper. 1/4" pin mounted metal letters are mounted to the copper and GFRC. Metal sign face of sign plan to be porcelain enamel with silkscreened images in polyurethane paint. Site plan mounted flush into GFRC.

Three ground lights in sidewalk to provide surface illumination. See Exhibit A, page 14.

2. Sign Type B - Entry Monument Sign

The entry monument signs shall provide project identification and shall be located opposite of each other on the NE and SE corners of the intersection of Sierra Point Parkway and Marina Boulevard.

Description: Foundation is landscaped according to Landscape Master Plan.

Identification of site "Koll Center Sierra Point". Seven radiused GFRC panels set on grass mounds. Central pedestal is 2 feet above sidewalk, 6 feet back. Remaining pedestal decreasing in height to be placed behind one another at intervals of 1 foot. Metal letters pin mounted to polished copper sign blade with cut-outs of each letter mounted in front of fluorescent tubes.

Ground lighting located in front of central pedestal for GFRC only and between each pedestal. See Exhibit D, page 15.

3. Sign Type C - Day Access Sign

These signs shall give direction to water access as required by the Day Conversation Development Commission.

Description: Sign face to be colored laminate with adhesive applied directional arrow and type. Laminate is mounted to wood core which is supported by wood ties bolts through center of tie. See Exhibit C, page 16.

4. Sign Type D-Building Identification Sign

These signs are designed in a monument format to provide building identity at all major office building entrances.

Description: Monument structure built of metal, stone and/or concrete on a concrete foundation; 68-72 inches tall (including exposed foundation), 75-85 inches wide, and 10-15 inches thick; identifying the location and the owner(s) and/or tenant(s) of the building. *The Planning Commission may approve monument signs exceeding the 72-inch height limit in cases where hotel and restaurant uses occupy sites with multiple street frontage in order to make clearer the primary entrance to the site.*

Illumination of the surface of the sign may be provided by lights located in the ground. Backlighting of any reveals may be provided by neon or fluorescent lighting inside the monument structure.

A building permit shall be obtained prior to installation of any sign 72 inches or greater in height above grade or for any illuminated sign per the Uniform Sign Code.

5. Sign Type E - Parking, directional loading/unloading signs

These signs shall provide identification of direction of parking; direction of hotels, harbor master and other amenities; and loading and unloading areas.

Description: Foundation is landscaped according to location and Landscape Master Plan.

Metal sign face to be porcelain enamel mounted with tamper proof bolts on all four corners. Dark grey characters are silkscreened in polyurethane paint on light grey field. One inch square metal tubing forms sign structure, mounted in metal sleeve which is bolted. Sleeve is set in a concrete foundation. Metal tubing to be painted (polyurethane). See Exhibit E, page 18.

6. Sign Type F - Stop Signs

Description: Foundation is landscaped according to location and Landscape Master Plan.

Metal sign face to be porcelain enamel, mounted with tamperproof bolts on four corners. White characters silkscreened in polyurethane paint on red field. One inch square metal tubing forms sign structure, mounted in metal sleeve which is then bolted. Sleeve is set in a concrete foundation. Metal tubing to be painted (polyurethane). See Exhibit F, page 19.

7. Sign Type G - Directional Sign

Description: Foundation is landscaped according to location and Landscape Master Plan.

Metal sign face to be porcelain enamel, mounted with tamper proof bolts on all four corners. Dark grey characters silkscreened in polyurethane paint on light grey field. One inch square metal tubing mounted in metal sleeve which is then bolted. Sleeve is set in a concrete foundation. Metal tubing to be painted (polyurethane). See Exhibit G, page 20.

8. Sign Type H - Exit Sign

This sign shall identify exits from parking areas.

Description: Foundation is landscaped according to location and Landscape Master Plan.

Metal sign face to be porcelain enamel, mounted with tamper proof bolts on all four corners. Dark grey characters silkscreened in polyurethane paint on light grey field. One inch square metal tubing forms sign structure, mounted in metal sleeve which is then bolted. Sleeve is set in a concrete foundation. Metal tubing to be painted (polyurethane). See Exhibit H, page 21.

9. Sign Type I - Street Identification Signs

Street identification signs shall be located at all major intersections.

Description: Foundation is landscaped according to Landscape Master Plan.

Metal sign face to be porcelain enamel, mounted with tamper proof bolts on all four corners. Dark grey characters silkscreened in polyurethane paint on light grey field. One inch square metal tubing around the sign blade is attached to four one inch tubes to form the sign post. Post is mounted in metal sleeve which is then bolted. Sleeve is set in a concrete foundation. Metal tubing to be painted (polyurethane). See Exhibit I, page 22.

REVISED
GENERAL SIGN STANDARDS
KOLL CENTER SIERRA POINT

(page 13)

Amended 1/9/03 per SR-9-02 &
1/28/10 per SR-1-10

GROUP III – TEMPORARY GROUND SIGNS

See attached Exhibit K.

Note that temporary ground signs advertising the lease of all or a portion of a building shall be subject to the same provisions as “For Sale” signs.

GROUP IV – COMMERCIAL SIGNS

These signs will be considered separately at the time these uses are submitted to the City for review. These signs must be approved by the Koll Center Sierra Point Design Review Committee and the City of Brisbane Planning Commission.

GROUP V – TEMPORARY BANNERS

The Planning Director may grant Sign Review approval for temporary banners of up to 200 sq. ft. total for new hotel operators. Such banners shall be displayed for no more than 90 days.

Temporary banners advertising all or a portion of an office building for lease shall be subject to Sign Review approval by the Planning Director. The number, size, dimensions and location of the banners shall comply with the Building-Mounted Signage Standards, treating them as temporary replacements for permanent signs. The banner colors and design shall be subject to the approval of the Planning Director. The banners shall be removed within 10 days after finalization of the lease. No building shall display such banners for more than 9 months within any calendar year.

Temporary banners for all other uses shall be subject to the provisions of Brisbane Municipal Code Table 17.34.020.

BUILDING-MOUNTED SIGNAGE ON OFFICE BUILDINGS AND HOTELS

These signs are subject to the Koll Center Sierra Point Building-Mounted Signage Standards.



PLAN

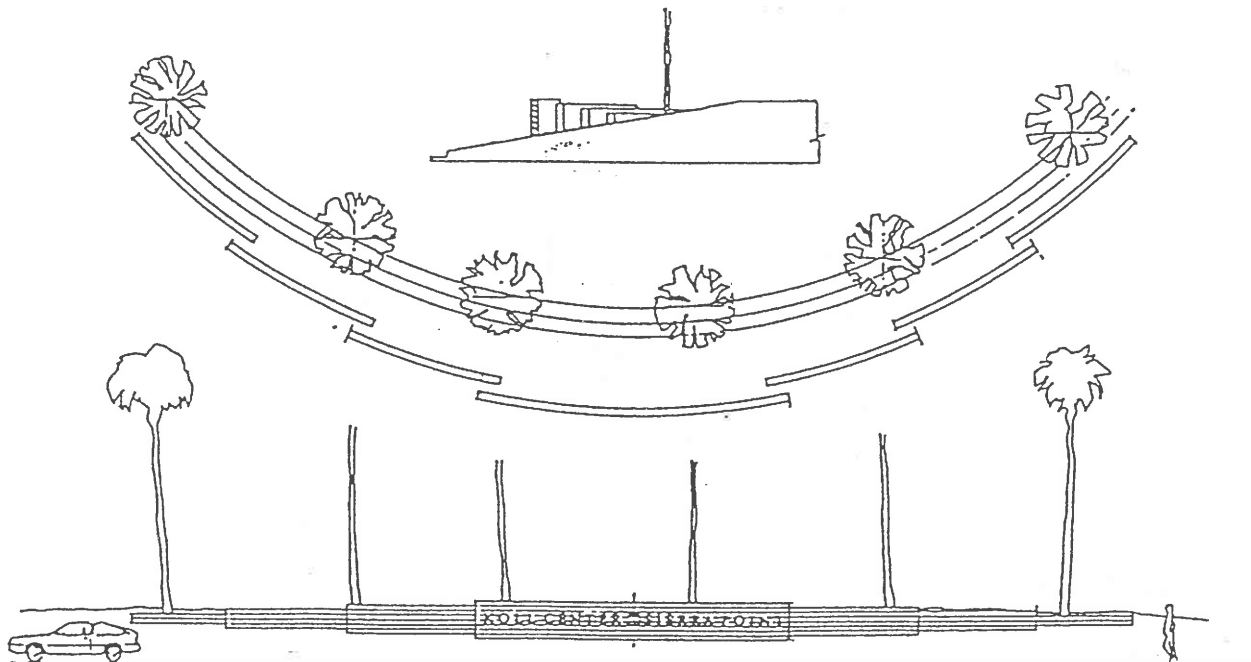
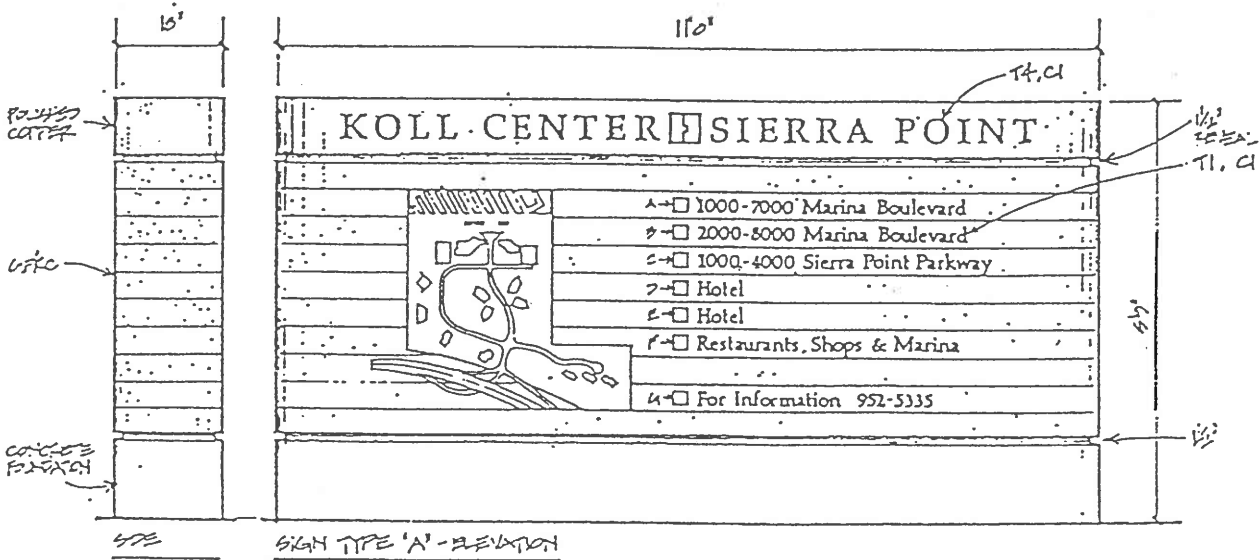

SIGN TYPE "B" PLAN AND ELEVATION

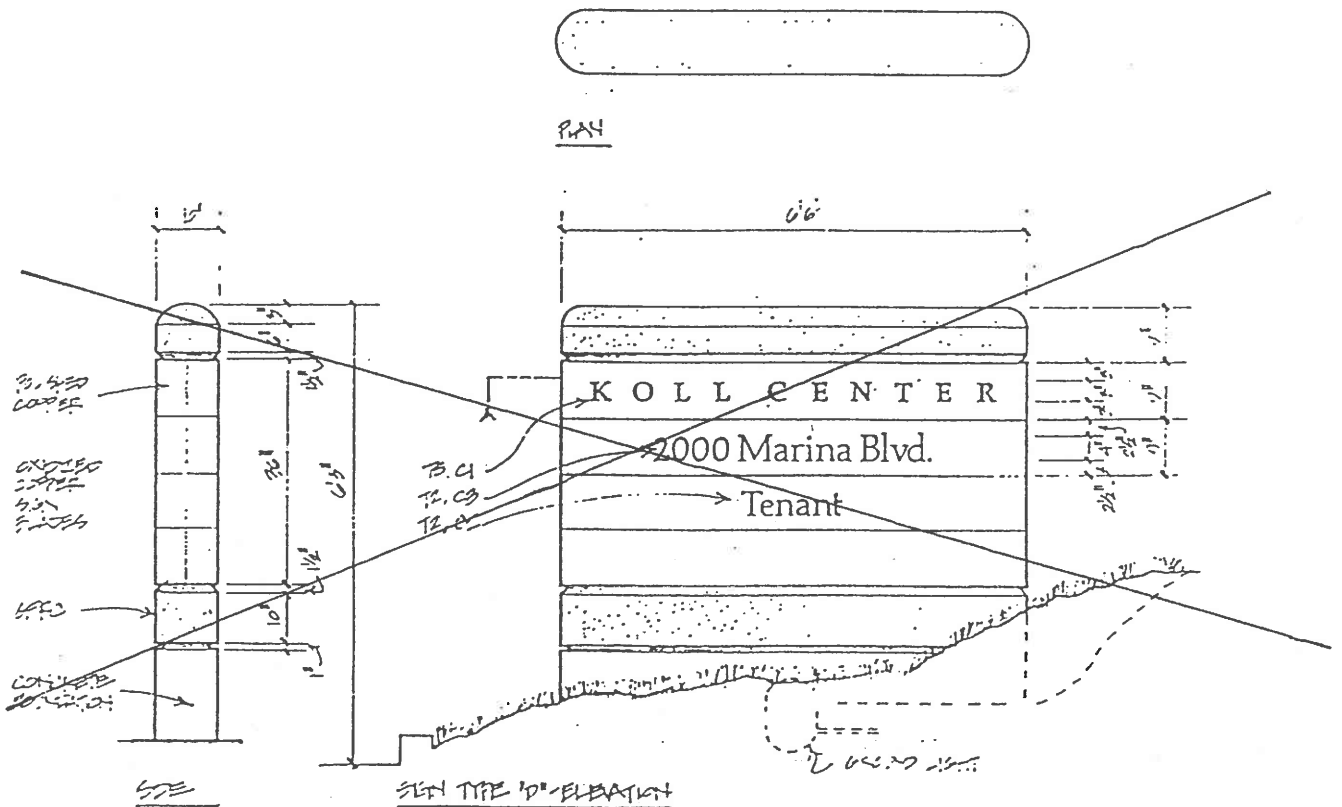
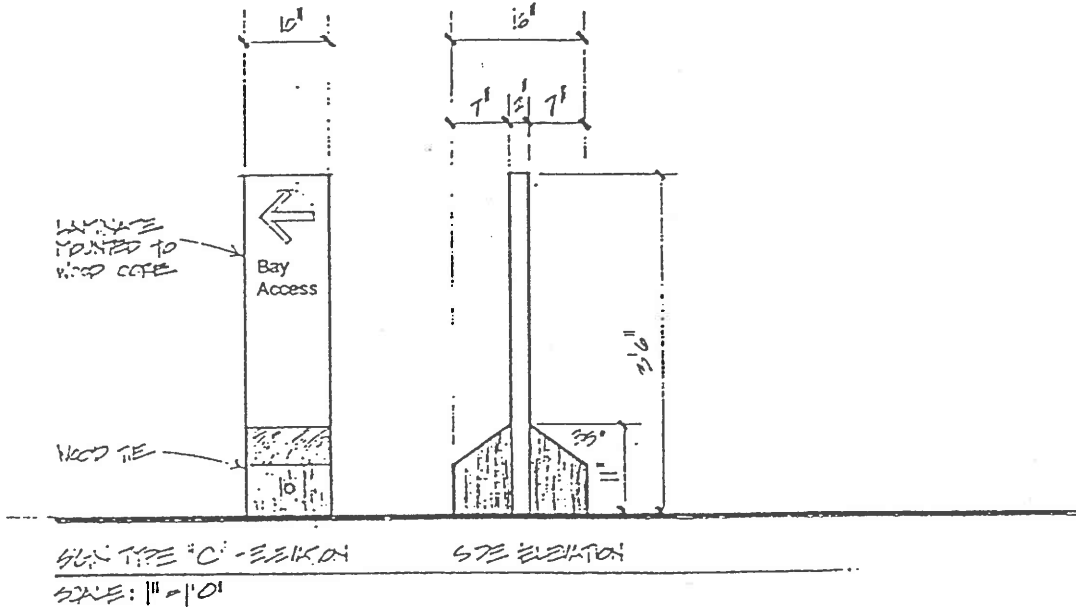

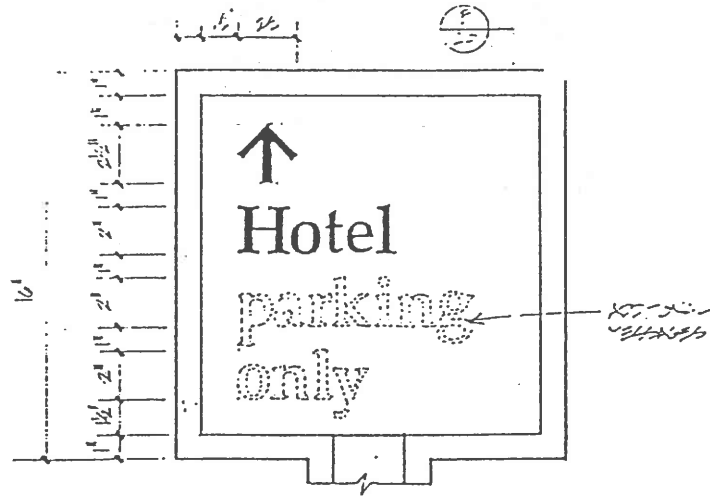

DETAIL
1/4" = 1'

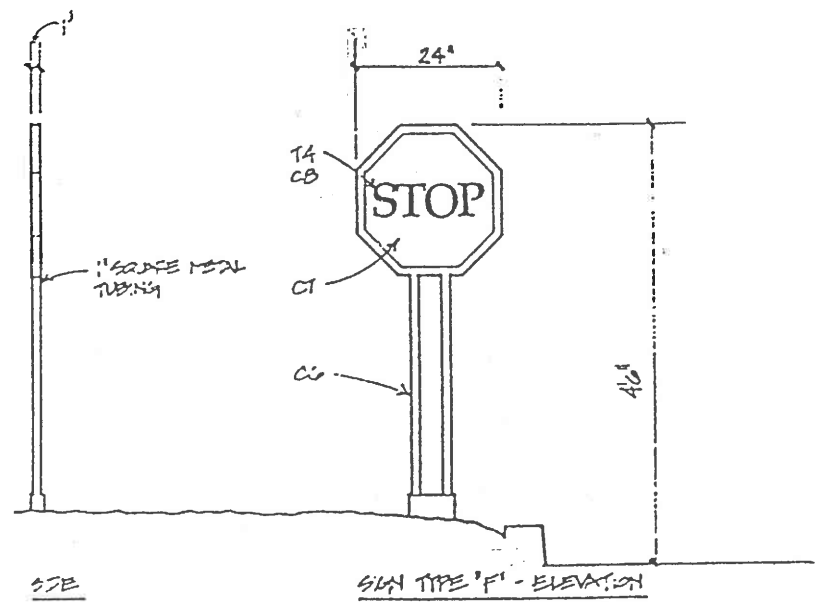
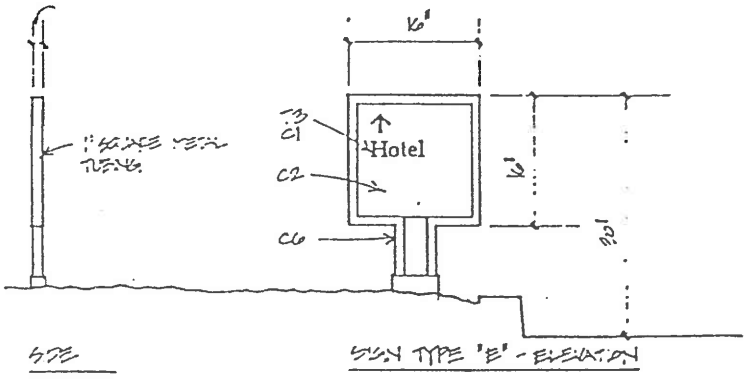

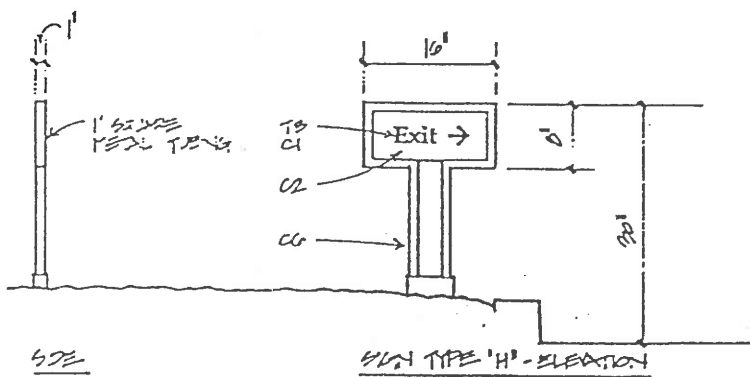
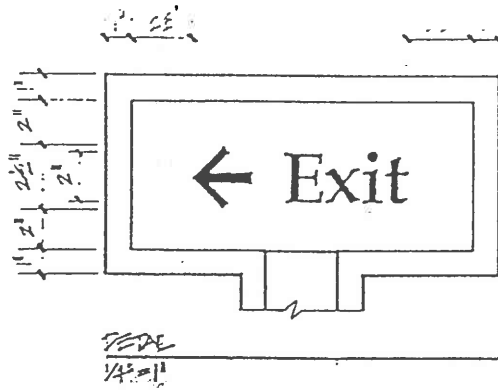
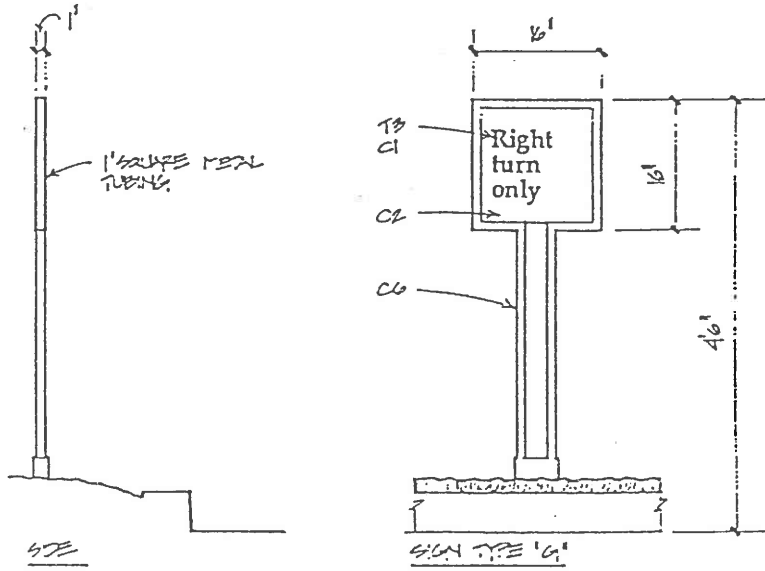

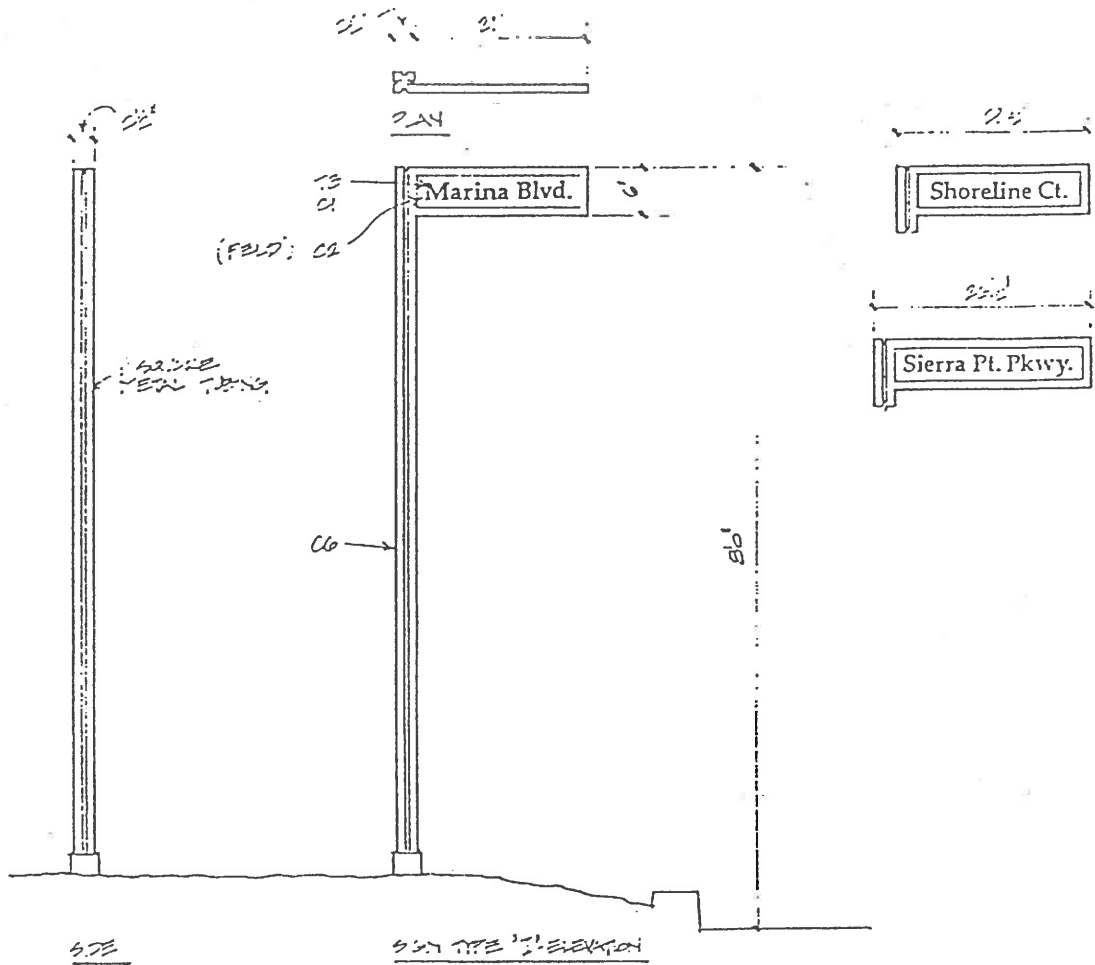

abcdefghijklmnopqrstuvwxy z 1234567890
 ABCDEFGHIJKLMNOPQRSTU VWXYZ

PLANO TYPE FACE

MODEL	CAP HI	COLOR
T1	24"	C1
T2	4"	C2
T3	4"	C3 (S-FL)

abcdefghijklmnopqrstuvwxy z 1234567890
 ABCDEFGHIJKLMNOPQRSTU VWXYZ

PLANO FOR TYPE FACE

MODEL	CAP HI	COLOR
T1	24"	C1
T2	4"	C2
T3	4"	C1

EXHIBIT B

GROUP III - TEMPORARY GROUND SIGNS

Temporary ground signs advertising the sale of the premises upon which the sign is located shall be allowed without review, subject to compliance with the following:

- No more than one "For Sale" sign shall be permitted per parcel.
- "For Sale" signs may be located on either street or freeway frontage, but shall not be located within the public right-of-way or any other location off-site, and in no event shall be less than 10 ft. from the back of the street curb or sidewalk (when present).
- "For Sale" signs shall be located at least 20 ft. from any driveway.
- Each sign face shall not exceed 4 ft. by 6 ft., and the total combined sign area shall not exceed 48 sq. ft.
- Signs may have two faces, if the angle between the two faces is no greater than 90 degrees.
- "For Sale" signs shall not be illuminated, reflective, rotating, wind-driven, flashing, animated or revolving.
- A building permit shall be obtained prior to installation of any sign 6 ft. or greater in height above grade per the Uniform Sign Code. Three sets of construction plans consistent with the sign program, required fees, and additional information as necessary shall be submitted to the City of Brisbane Building Department.
- "For Sale" signs shall be removed not later than 10 days after finalization of the sale of the property.
- All signs shall be maintained in a neat and orderly fashion. Periodic inspections shall be made by Koll Center Sierra Point. Prompt correction of any deficiencies shall be made by the entity responsible for the maintenance of said sign(s).

Temporary ground signs for any other purpose shall be considered separately as needed. They must be approved by the Koll Center Sierra Point Design Review Committee and the City of Brisbane Planning Commission.

EXHIBIT K

GROUP III - TEMPORARY GROUND SIGNS

Temporary ground signs advertising the sale of the premises upon which the sign is located shall be allowed without review, subject to compliance with the following:

- No more than one "For Sale" sign shall be permitted per parcel.
- "For Sale" signs may be located on either street or freeway frontage, but shall not be located within the public right-of-way or any other location off-site, and in no event shall be less than 10 ft. from the back of the street curb or sidewalk (when present).
- "For Sale" signs shall be located at least 20 ft. from any driveway.
- Each sign face shall not exceed 4 ft. by 6 ft., and the total combined sign area shall not exceed 48 sq. ft.
- Signs may have two faces, if the angle between the two faces is no greater than 90 degrees.
- "For Sale" signs shall not be illuminated, reflective, rotating, wind-driven, flashing, animated or revolving.
- A building permit shall be obtained prior to installation of any sign 6 ft. or greater in height above grade per the Uniform Sign Code. Three sets of construction plans consistent with the sign program, required fees, and additional information as necessary shall be submitted to the City of Brisbane Building Department.
- "For Sale" signs shall be removed not later than 10 days after finalization of the sale of the property.
- All signs shall be maintained in a neat and orderly fashion. Periodic inspections shall be made by Koll Center Sierra Point. Prompt correction of any deficiencies shall be made by the entity responsible for the maintenance of said sign(s).

One "Subdivision For Sale or Lease" temporary ground sign, advertising the sale of vacant parcels and/or future leasable office space on such parcels within the Sierra Point subdivision, shall be allowed, subject to compliance with the following:

- The "Subdivision For Sale or Lease" sign shall be located within the boundaries of the subdivision and shall not be located within the public right-of-way.

- The "Subdivision For Sale or Lease" sign may have two faces in a "V"-shaped arrangement with a 65-85 degree angle between them, each sign face shall not exceed 40 ft. by 18 ft., and the sign's supports shall not exceed 7 ft. in height.
- The "Subdivision For Sale or Lease" sign may be illuminated as approved by the Zoning Administrator per Brisbane Municipal Code Section 17.36.060.D.5 and Table 17.36.020. The "Subdivision For Sale or Lease" sign shall not be reflective, rotating, wind-driven, flashing, animated or revolving.
- A building permit shall be obtained prior to installation of the sign. Three sets of construction plans consistent with the sign program, required fees, and additional information as necessary shall be submitted to the City of Brisbane Building Department.
- The "Subdivision For Sale or Lease" sign shall be maintained in a neat and orderly fashion. Periodic inspections shall be made by Koll Center Sierra Point. Prompt correction of any deficiencies shall be made by the entity responsible for the maintenance of said sign(s).
- The "Subdivision For Sale or Lease" sign shall only be located on a vacant parcel with freeway frontage. It shall be removed prior to occupancy of any building developed on the same parcel. Relocation of the "Subdivision For Sale or Lease" sign to another site with freeway frontage within the subdivision shall be subject to Sign Review by the Zoning Administrator. The "Subdivision For Sale or Lease" sign shall no longer be allowed once all of the parcels with freeway frontage within the subdivision have been developed.

Temporary ground signs for any other purpose shall be considered separately as needed. They must be approved by the Koll Center Sierra Point Design Review Committee and the City of Brisbane Planning Commission.



THE OPUS GROUP
ARCHITECTS
CONTRACTORS
DEVELOPERS

OPUS WEST CORPORATION
A member of The Opus Group

6160 Stoneridge Mall Road, Suite 360
Pleasanton, CA 94588
Phone 925-463-9254
Fax 925-463-9368
www.opuscorp.com

June 25, 2003

Mr. Tim Tune
Senior Planner
City of Brisbane
50 Park Place
Brisbane, CA 94005



Dear Tim:

I have attached a copy of the pertinent sections of the CC&Rs recorded October 28, 1998. The CC&Rs require the applicant to receive written approval by Declarant for this type of improvement. Please see Sections: 1.40, 1.68, 4.1 and 5.6.

Sincerely,
Opus West Corporation
for Sierra Point, LLC

Randall R. Ackerman
Vice President
Real Estate Development

cc: Matteson Realty Services,
Mr. Russell Kessler

Exhibit "A-2" as the Ground Lease Parcel and attached hereto and incorporated herein. The Land Area of the Ground Lease Parcel is shown on **Exhibit "A-2"** attached hereto.

1.38 Ground Lessee. The term "Ground Lessee" shall refer to the lessee of the Ground Lease Parcel under the Ground Lease and its successors in interest as lessee under the Ground Lease.

1.39 Hazardous Materials. The term "Hazardous Materials" means and refers to any toxic substance, material or waste which is or becomes (i) regulated by any local governmental authority, the State of California or the United States Government; (ii) defined as a "solid waste", "sludge", "hazardous waste," "extremely hazardous waste," "restricted hazardous waste," "Non-RCRA hazardous waste," "RCRA hazardous waste," or "recyclable material," under any federal, state or local statute or regulation promulgated thereunder, including, without limitation, Sections 25115, 25117, 25117.9, 25120.2, 25120.5, 25122.7, or listed pursuant to Sections 25140 and 25141, of the California Health and Safety Code, Division 20, Chapter 6.5 (Hazardous Waste Control Law), (iii) defined as a "Hazardous Substance" under Section 25316 of the California Health and Safety Code, Division 20, Chapter 6.8 (Carpenter-Presley-Tanner Hazardous Substance Account Act), (iv) defined as a "Hazardous Material," "Hazardous Substance" or "Hazardous Waste" under Section 25501 of the California Health and Safety Code, Division 20, Chapter 6.95 (Hazardous Materials Release Response Plans and Inventory); (v) defined as a "Hazardous Substance" under Section 25281 of the California Health and Safety Code, Division 20, Chapter 6.7 (Underground Storage of Hazardous Substances), (vi) petroleum products, (vii) asbestos, as defined in Section 25918 of the California Health and Safety Code, Chapter 10.35 (Asbestos Note Function) petroleum waste products, petroleum contaminants, including, without limitation, petroleum, gasoline, used oil, crude oil, waste oil and any fraction thereof, natural gas, methane gas, natural gas liquefied, natural gas, or synthetic fuels, (viii) materials defined as hazardous or extremely hazardous pursuant to Article 2 of Title 22 of the California Administrative Code, Division 4.5, Chapter 10, (ix) pesticides, (x) polychlorinated biphenyls, (xi) defined as a "Hazardous Substance" pursuant to Section 311 of the Federal Water Pollution Control Act (33 U.S.C. Section 1251 et seq.), (xii) defined as a "Hazardous Waste" pursuant to Section 1004 of the Federal Resource Conservation and Recovery Act, 42 U.S.C. Section 6901 et seq., (xiii) defined as a "Hazardous Substance" or "Mixed Waste" pursuant to Section 101 of the Comprehensive Environmental Response Compensation and Liability Act, 42 U.S.C. Section 9601 et seq., and regulations promulgated thereunder, (xiv) defined as a "Hazardous Substance" pursuant to Section 401.15 of the Clean Water Act, 40 C.F.R. 116, (xv) defined as an "Extremely Hazardous Substance" pursuant to Section 302 of the Superfund Amendments and Reauthorizations Act of 1986, 42 U.S.C. Section 11002 et seq., or (xvi) defined as "medical waste" pursuant to Section 25023.2 of the California Health and Safety Code, Chapter 6.1 (Medical Waste Management Act).

 1.40 Improvement; Improvements. The term "Improvement" or "Improvements" means buildings, outbuildings, roads, driveways, driveway cuts, parking areas, Berms, fences, screening walls and barriers, retaining walls, stairs, decks, water lines, sewers, electrical and gas distribution

facilities, hedges, windbreaks, plantings, planted trees and shrubs, poles, antennae, microwave dishes, solar panels, Signs (as defined below), loading areas and all other structures, installations and landscaping of every type and kind, whether above or below the land surface.

1.41 Invitee. The term "Invitee" means any person whose presence within the Project is approved by or is at the request of a particular Owner, including, but not limited to, lessees, tenants, employees, licensees or invitees of Owners, tenants or lessees.

1.42 Land Area. The term "Land Area" means the gross acreage of the real property situated within a Parcel, with fractional portions of an acre being rounded to the nearest hundredth of an acre. The Land Area for the Parcels initially subject to this Declaration is set forth on Exhibit "A-1" attached hereto and incorporated herein and the Land Area for any Parcels which may be annexed to this Declaration is set forth on Exhibit "B-1" attached hereto and incorporated herein. Upon any subdivision of the Parcels, the Land Area for such subdivided Parcels shall be the area of the Parcel designated on the final subdivision or parcel map, rounded to the nearest hundredth of an acre and in such case, the Association may, but shall not be required to, record a Supplemental Declaration specifying the Land Area of the newly subdivided Parcel. If no designation is included on the parcel or subdivision map, the Land Area shall be the area designated by Declarant's engineer, or, if the Declarant's Rights have expired, the Association's engineer and in such case, the Association shall be required to, record a Supplemental Declaration specifying the Land Area of the newly subdivided parcel.

1.43 Landscaping and Lighting District. The term "Landscaping and Lighting District" means the Sierra Point Landscaping and Lighting District formed pursuant to City of Brisbane City Council Resolution No. 92-44.

1.44 Landscaping and Lighting District Properties. The term "Landscaping and Lighting District Properties" means those portions of the Project which are currently being maintained by the Landscaping and Lighting District. Upon any dissolution of such district or relinquishment of the right to maintain such properties pursuant to Section 8.2 of this Amended Declaration, the Landscaping and Lighting District Properties shall, if the Association assumes such maintenance obligations pursuant to Section 3.1.16 of this Declaration, be included within the definition of the Common Facilities.

1.45 Lessee. The term "Lessee" means each Person who, at any given time, is leasing a Parcel or a building or a portion of a Parcel or a building on a Parcel from an Owner under a written lease agreement. An Owner may designate, by a written instrument delivered to the Association, a Lessee as primarily responsible for the burdens and obligations imposed herein during the term of the lease, and may further designate to such Lessee the right to exercise the powers granted to such Owner under this Declaration. Such designation, however, shall not result in a release of such Owner from any responsibility and liability hereunder. Such assignment shall become effective upon delivery of the written assignment to the Association.

1.63 RWQCB Order. The term "RWQCB Order" refers to Order No. 96-058 issued by the RWQCB, as it may be amended, supplemented or replaced from time to time and any additional orders, decrees, directives or requirements which may be imposed upon the Property by the RWQCB with respect to the condition of Sierra Point as a former landfill.

1.64 Shuttle Bus Expenses. The term "Shuttle Bus Expenses" refers to the expenses incurred for the operation of any shuttle bus adopted under any TSM Program (as defined below) or as otherwise implemented for the benefit of the Project by the Association.

1.65 Sierra Point. The term "Sierra Point" refers to the area situated within the City of Brisbane and City of South San Francisco within which the Property is situated and known as "Sierra Point" and described on the Site Plan (as defined below).

1.66 Signage Easements. The term "Signage Easements" shall refer to the areas shown on the Site Plan over which the Association shall have an easement for installation, maintenance and repair of signage for the benefit of the Project.

1.67 Site Plan. The term "Site Plan" refers to the site plan of Sierra Point attached hereto as **Exhibit "E"** and incorporated herein.

 1.68 Sign. The term "Sign" means any structure, device or contrivance, permanent or temporary, electric or nonelectric, visible from adjacent property, upon or within which any poster, bill, bulletin, printing, lettering, painting, device or other display or advertising of any kind whatsoever is used, placed, posted, mounted, or otherwise fastened or affixed.

1.69 Street or Streets. The term "Street" or "Streets" means any public street, highway, road, or thoroughfare within or adjacent to the Property and any private street, road, or thoroughfare shown on any recorded subdivision or parcel map or record of survey, whether designated thereon as street, boulevard, place, drive, road, court, terrace, way, lane, circle or otherwise.

1.70 Super Majority of the Voting Power. The term "Super Majority of the Voting Power" means the affirmative vote or consent of seventy-five percent (75%) of the Voting Power.

1.71 Supplemental Declaration. The term "Supplemental Declaration" means that document which may be executed and recorded by Declarant prior to or contemporaneous with the conveyance of a Parcel to a third party by Declarant or by the Association upon consent by the Owner of the Parcel as to which the restriction is being imposed, which document may impose: (i) additional restrictions for the Parcel in question; (ii) additional easements benefitting or burdening said Parcel; (iii) additional maintenance obligations of the Association or the Owner of the Parcel in question; and/or (iv) such other items as Declarant may determine. After recordation, if a Supplemental Declaration only imposes obligations on some but not all of the Property, a

3.1.15 Association Property. The Association shall have the obligation to accept fee title to any real property included within the Annexable Property which is conveyed to the Association by the Declarant and to maintain such Property in accordance with the requirements of this Amended Declaration.

3.1.16 Landscaping and Lighting District Properties and Contracts with the City. The Association shall have the power to enter into contracts or agreements with the City wherein the Association agrees to perform obligations which are otherwise being performed by the City and the cost thereof shall be included as a Common Expense. The Association shall have the right to assume the responsibility for maintenance of the Landscaping and Lighting District Properties and to cooperate with the City of Brisbane in any actions to dissolve the Landscaping and Lighting District.

3.2 Personal Liability. No member of the Board, or any committee of the Association, or any officer, agent, employee or attorney of the Association, or any manager or Declarant, or any officer, agent, member, shareholder, director or employee of Declarant, shall be personally liable to any Owner, or any other party, including the Association, for any actions, damages, liabilities, losses, fines or penalties, including, without limitation, attorneys' fees and costs suffered or claimed on account of any act, omission, error, or negligence of any such individual if such individual has, on the basis of such information as may be possessed by such individual or it, acted in good faith without willful or intentional misconduct. Each person serving on the Board does so as a representative of the Owner and not in his or her personal capacity and, in no event shall such Person have any personal liability as a result of its serving on the Board.

ARTICLE 4

CONSTRUCTION OF IMPROVEMENTS

* 4.1 Approval by Declarant for all Improvements. No Improvements shall be erected, placed, constructed, replaced, substantially remodeled, rebuilt or reconstructed, maintained or permitted to remain on any Parcel until Plans and Specifications have been submitted to and approved in writing by Declarant; provided, however, that plans for tenant improvements in buildings for which Declarant has approved the Plans and Specifications need not be submitted for approval unless such tenant improvements include facilities for processing or handling of Hazardous Materials. Such Plans and Specifications shall be submitted in duplicate over the authorized signature of the applicant ("Applicant") and the Owner of the Parcel. Such plans and specifications shall be in such form and shall contain such information as may be required by the Declarant, but shall in any event include the following:

4.1.1 Site Development Plan. A site development plan of the Parcel showing the grading and drainage scheme, location and dimensions of all proposed buildings, driveways, parking areas, walkways, landscape areas, loading areas, storage and refuse areas, and walls with respect to the particular Parcel and with respect to structures on adjoining Parcels;

5.5.3 Refuse Collection. All outdoor refuse collection areas shall be screened so that such areas are not visible from adjacent Property or Streets. Said screening shall consist of fencing approved by Declarant.

* 5.6 Signs. Every exterior Sign, temporary or permanent, and all parts thereof shall conform to the signage plan approved by Declarant pursuant to **Article 4**.

5.7 Utilities. All electrical, telephone, gas, water, storm drain, sewer and other utility lines on each Parcel shall be installed underground.

5.8 Construction of Clay Cap. Each Owner shall construct upon such Owner's Parcel a clay cap of at least the thickness and constructed of materials meeting specifications set forth in the RWQCB Order in conjunction with the construction of any structures thereon, or at any earlier time if required by any Governmental Requirements, unless Declarant has previously constructed such clay cap on that Parcel. The clay cap shall be constructed in accordance with the Plans and Specifications approved by Declarant pursuant to **Article 4**. The clay cap shall be constructed and compacted to form a junction with the clay cap on any adjacent Parcel so that the clay caps and their junction form a substantially unbroken clay cap across the Parcels. If any existing clay cap is excavated or cut into, the portions removed shall be replaced to the same thickness and with materials meeting the same specifications as originally constructed. The replacement portion of the clay cap shall be constructed to form a junction with the remainder of the existing clay cap on adjacent parcels.

5.9 Variances. Except for the requirements set forth in **Section 5.8** of this Declaration, Declarant shall have the exclusive right to grant to any Parcel or Owner thereof such variances from the provisions of this Article as it, in its sole discretion, determines is in the best interests of the Property. Any variance granted hereunder shall be effective only if made in writing.

5.10 Determination Of Violation. Declarant shall have the power to determine, in its sole judgment, upon its own initiative or upon complaint by any Owner, whether a violation of any provision of this Article is occurring upon any Parcel, and any such determination by Declarant shall be conclusive.

ARTICLE 6

REGULATION OF OPERATIONS AND USES

6.1 Permitted Uses. Except as otherwise specifically prohibited herein, any use which is (a) permitted by the general plan designation and zoning of a Parcel and (b) complementary with the Design Guidelines and the general plan for development of the Property may be conducted upon a Parcel with the prior written approval of Declarant. Declarant in its discretion shall determine whether a use is complementary and no use shall be deemed complementary unless approved by